

## KRAIBURG WELA LongLine

### prerequisites:



#### concrete area:

- no holes
- no elevations
- with at least a 3 % slope

#### mats:

even temperature: minimum 5° C to maximum 30° C (store according to initial temperature)



for animal well-being some litter is necessary to absorb moisture (e.g. soft milled straw or mineral material)

### You will need this:

#### measuring:

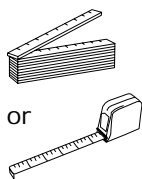

#### marking:

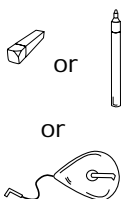

#### cutting:

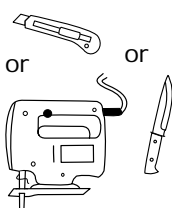

#### drilling and installing:

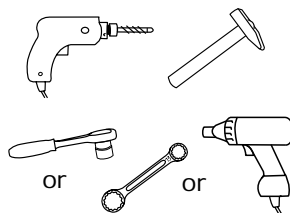

#### KRAIBURG fastening elements:

framing plugs ø 10 x 80 mm with  
• hexagon screw (SW 13) - A2  
• washer ø 40 mm - A2

framing plugs ø 10 x 100 mm with  
• hexagon screw (SW 13) - A2  
• washer ø 30 mm - A2

(fastening elements are part of delivery)

## 1 Placement line

188 cm for mat length 183 cm  
175 cm for mat length 170 cm  
170 cm for mat length 165 cm

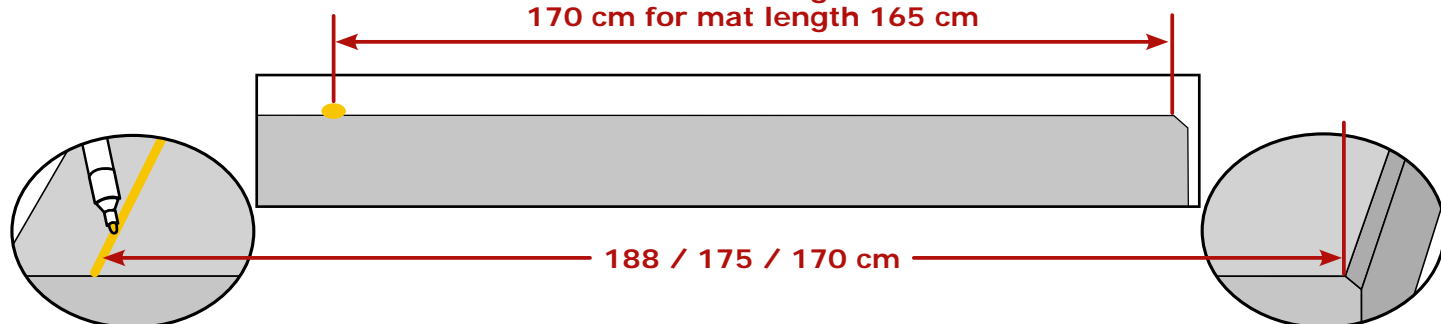

draw placement line in the front  
**Tip:** use a chalk line

measure from the rear  
concrete edge

## 2 Roll out / put in place

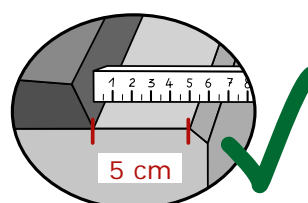
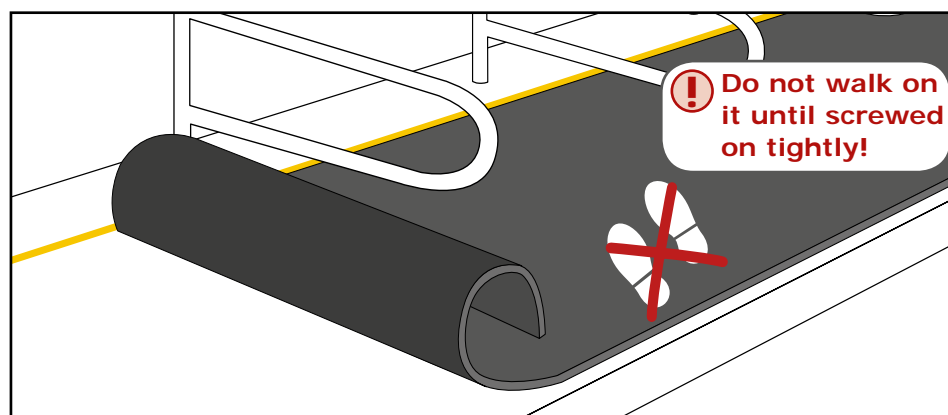

rear concrete edge:  
5 cm installation distance!

**The distance will decrease considerably within the first days after installation.**

**! Cutting out pockets for pillars, etc. is not possible!**

### 3 Fastening

**i** start in the middle and alternately work towards the right and to the left

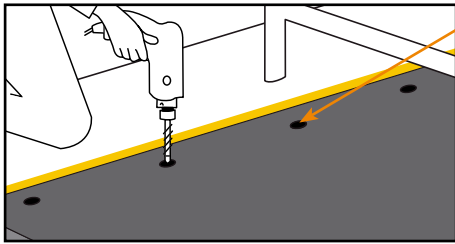

fasten at the front edge through the prefabricated fastening points

**!** Make sure the front edge of the mat is on the marking. If necessary, readjust.

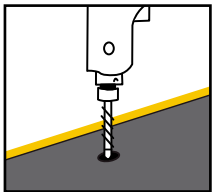
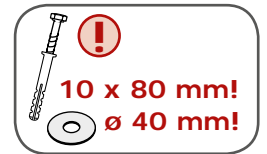

drill

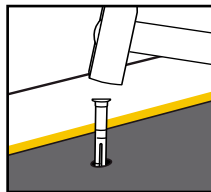

pound the plastic plugs in flush

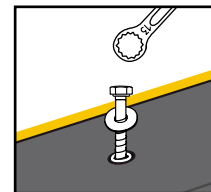

fasten screws and washers until they are seated evenly fast. **Do not overtighten!**

### 4 Fasten side mat edge with closure profile

**A** Position profiles

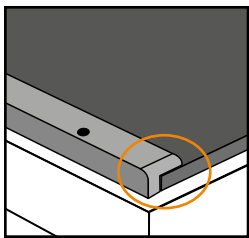

Left edge with profile **WELA-L**

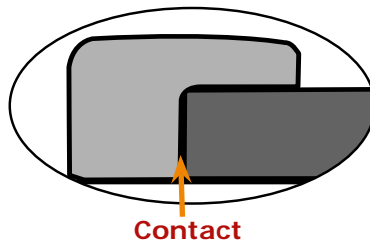

Contact

**!** DO NOT PRESS!

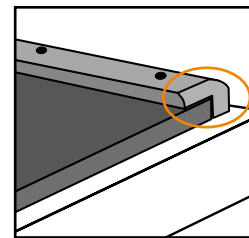

Right edge with profile **WELA-R**

- rounded off end on the rear edge
- flush with rear mat edge

**B** Fasten profiles

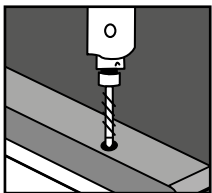

drill (fastening points)

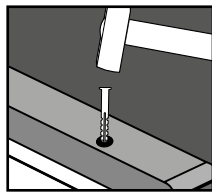

pound the plastic plugs in flush

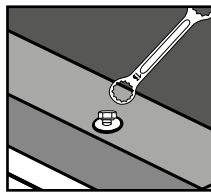

fasten screws and washers until they are seated evenly fast. **Do not overtighten!**

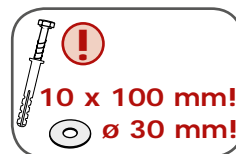

**i** tip: avoiding profile slippage:  
1. fix at one fastening point  
2. afterwards drill further holes and so on

### 5 Optional: connect two rolls with a middle profile (under a divider)

**A** Insert middle profile **WELA-M**

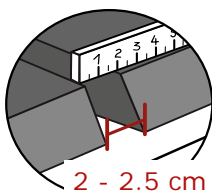

2 - 2.5 cm

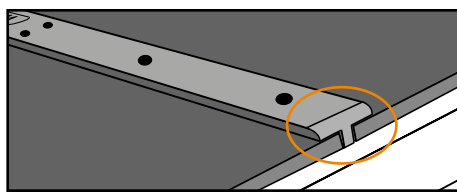

- rounded off end on the rear edge
- flush with rear mat edge

**!** DO NOT PRESS!

**B** Fasten profiles: see **4 B**